



NH KNIFE-BLADE

FUSE LINKS & FUSE BASES

gG

NH 800V AC

fuse links



NHC1



NH1



NH3

PROTECTING THE WORLD



RATED VOLTAGE
800V AC

RATED CURRENT
25A..63A

BREAKING CAPACITY
80kA

STANDARDS

IEC/EN 60269-1
IEC/EN 60269-2



NH 800V AC fuse links for output side of photovoltaic inverters

These knife type (NH) fuse links with high breaking capacity are intended for protection of the output side of new generation of photovoltaic inverters, with output voltage of 800V AC.

They are gG class and provide protection against overloads and short-circuits with rated voltages up to 800V +10%. The rated breaking capacity is 80 kA. They have a low values of power dissipations.

The range comprises the following fuse links:

→ Size NHC1 800V AC 25A to 63A

Manufactured with ceramic body with high withstand to internal pressure and thermal shock, that allows a high breaking capacity. Knife contacts are made of silver plated copper or brass.

They are manufactured according to IEC/EN60269 Standards and comply with RoHS directive.



Dimensions

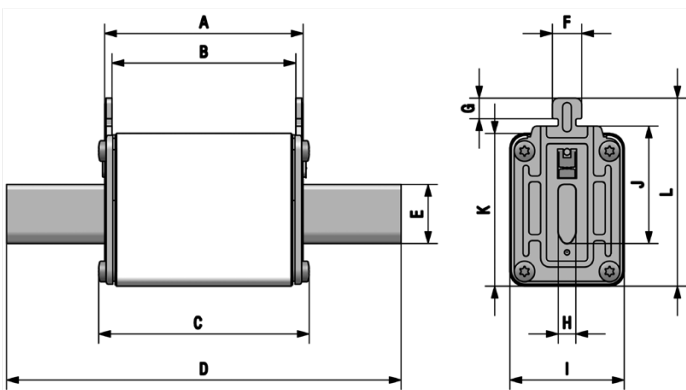

A	B	C	D	E	F	G	H	I	J	K	L
68	62	70,5	135	15	10	9,5	6	29	40	47	64

Weight 270gr

Range

I_n (A)	REFERENCE	PACKING Uni /BOX
25	385210	3/30
35	385220	3/30
40	385225	3/30
50	385230	3/30
63	385235	3/30



Technical data

Rated voltage	800V AC +10%
Rated current	25A...63A
Rated breaking capacity	80kA
Utilization category	gG
Rated frequency	42...62Hz
Storage temperature	-40°C ... 90°C
Operating temperature *	-40°C ... 80°C

* For ambient temperatures higher than 25°C it is necessary to apply a derating in maximum current.

Standards

IEC/EN 60269-1
IEC/EN 60269-2
RoHS Compliant



Power dissipation

I_n	PREARCING I^2t	OPERATING I^2t	POWER DISSIPATION
(A)	(A ² S)	(A ² S 800V ~)	(W)
25	1150	2770	4,1
35	2780	6700	4,8
40	4600	11080	5,0
50	4680	11300	5,3
63	9400	22670	6,1

Materials

Body	Steatite C221
Contact blades	Copper or brass (silver plated)
Plates	Aluminium
Screws	Zinc plated steel

t-I characteristics

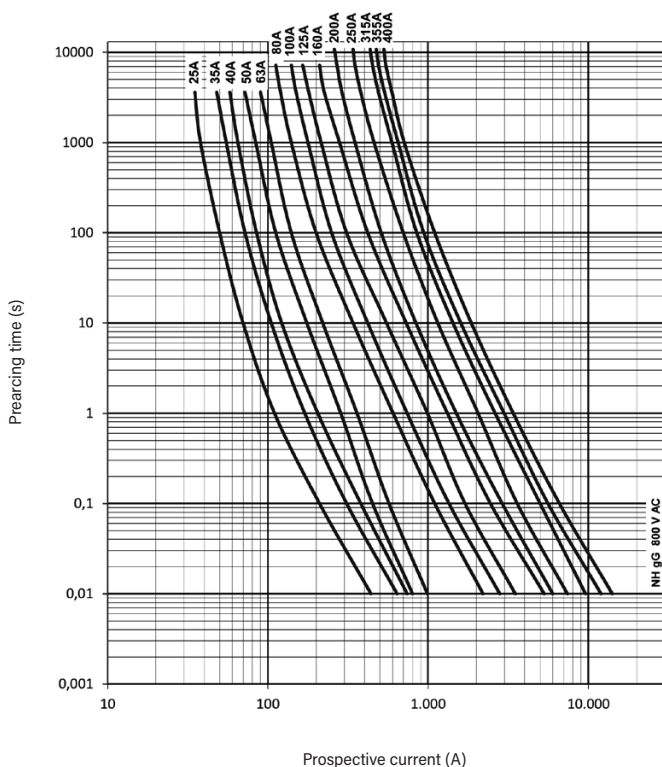

Cut-off characteristics

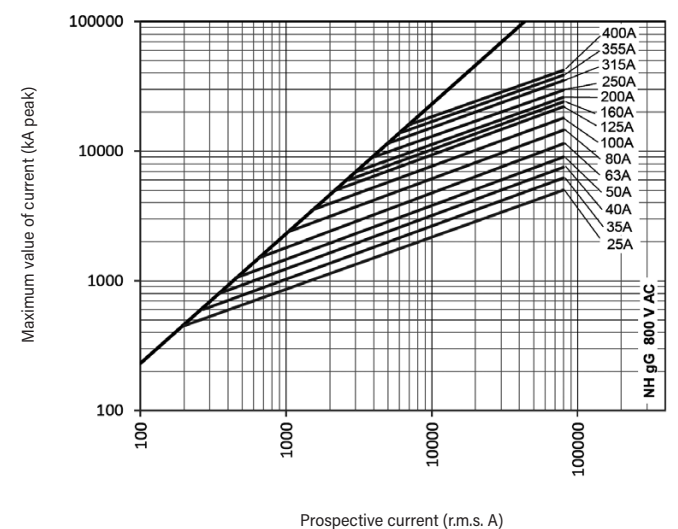



Ambient temperature derating factor

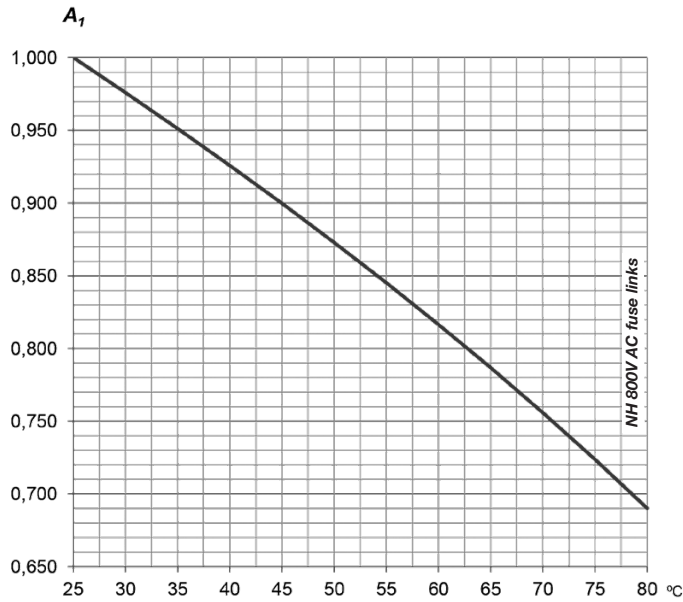

t_a (°C)	A_1
25	1,00
30	0,98
35	0,95
40	0,93
45	0,90
50	0,87
55	0,84
60	0,82
65	0,79
70	0,76
75	0,72
80	0,69

Correction factor for power loss

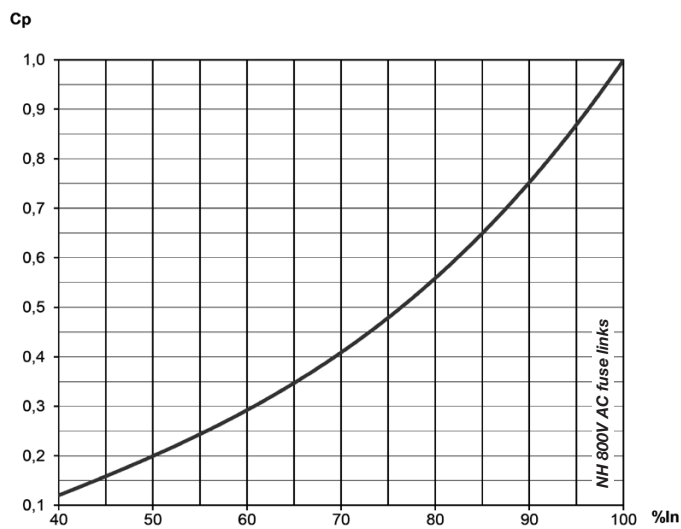

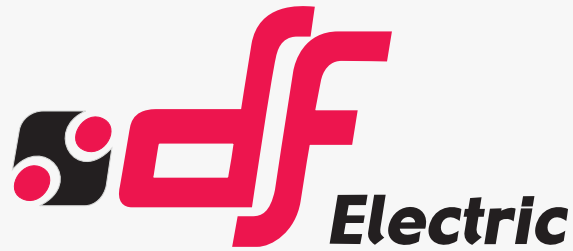

PROTECTING THE WORLD

HEAD OFFICE AND FACTORY

SILICI, 67-69
08940 CORNELLA DE LLOBREGAT
BARCELONA · SPAIN
Tel. +34 93 377 85 85
Fax +34 93 377 82 82

INTERNATIONAL SALES

Tel. +34 93 475 08 64
Fax +34 93 480 07 75
export@dfelectric.es

NATIONAL SALES

Tel. 93 475 08 64
Fax 93 480 07 76
comercial@dfelectric.es

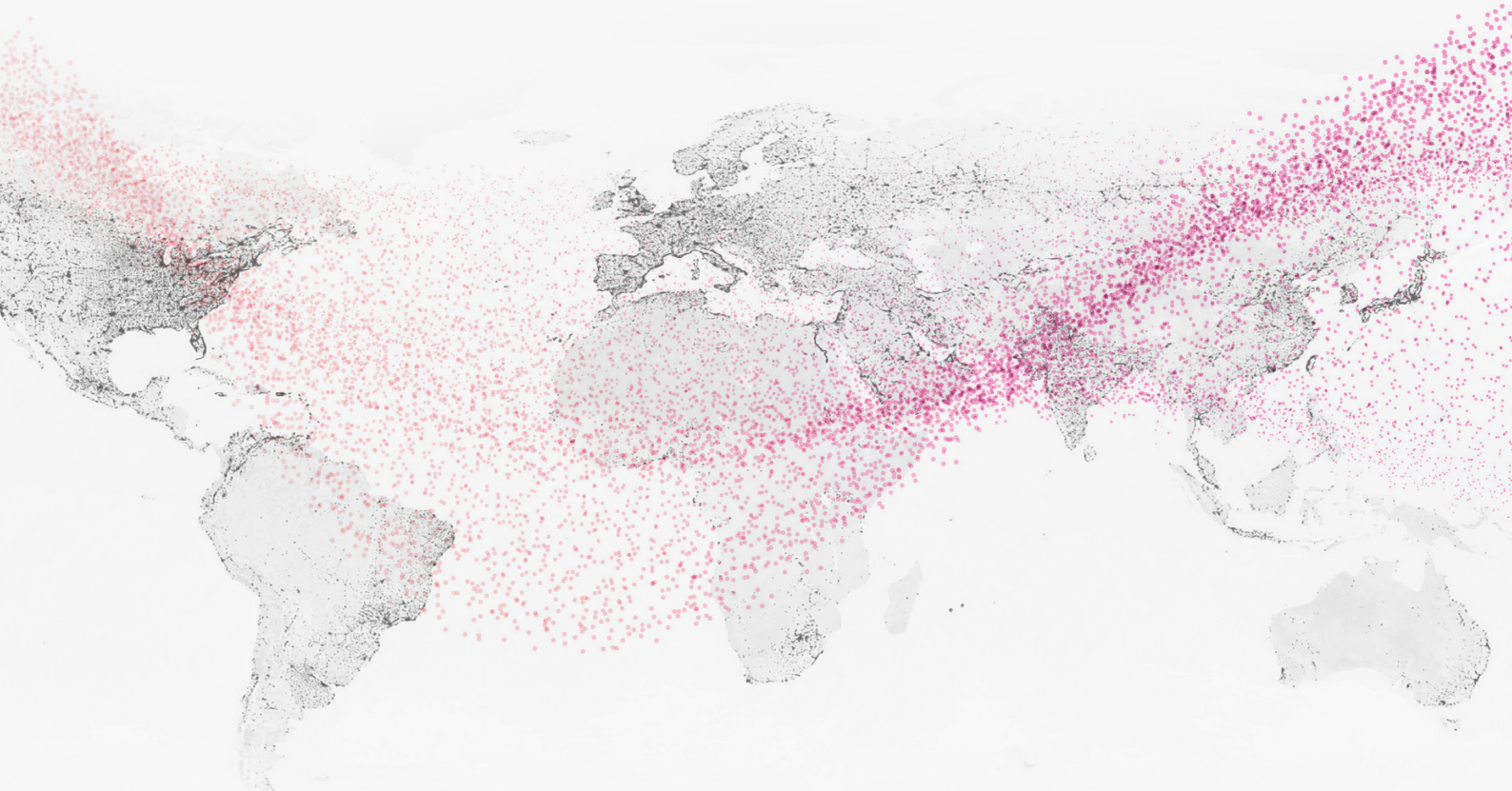

dfelectric.es



According to the waste of electrical and electronic equipment directive, electrical material should not be part of the usual waste. This symbol alerts users that these products should be recycled according to local environmental waste disposal regulations.



The "electro technical expert" logo marked on the products included in this data sheet indicates that the installation of these products must be carried out by expert personnel with specialized knowledge.



To prevent electrical hazards, carry out the installation without voltage.



Safety notice
Please capture the following QR code and read our safety notice carefully before installing our products.



The data reflected in this technical record are subject to the correct installation of the product in accordance with manufacturer's instructions, relevant installation standards and professional practices, maintained and used in applications for which they were made.

The products described in this document have been designed, developed and tested in accordance with specific standard. They are considered components that are integrated as part of installation, machine or equipment. The correct general operation of the referred product is responsibility of the manufacturer of the installation, machine or equipment.

DF ELECTRIC cannot guarantee the characteristics of an installation, machine or equipment that has been designed by a third party. Once a product has been selected, the user must verify that it is appropriate for its application, through the verifications and/or tests that it deems appropriate.

DF ELECTRIC retains the right to change the dimensions, specifications, materials or design of its products at any time with or without notice.

©2023 DF Electric. All rights reserved